

Owners Manual for Universal Motor Controllers (UMOCs)

Second Edition

Foreword

Caution

The information provided in this manual is intended for use by persons with appropriate technical skills. Any effort to perform repairs to, or service your unit without the proper tools or knowledge required for the work can result personal injury and product damage.

How To Report Errors

If, while reading through this manual, you discover an error in the technical information provided, Solectria asks that you notify its Customer Service Department at the phone number provided in your warranty. Please be prepared to provide the following information:

- Your name
- Name and edition of your manual
- Page number(s) where the error(s) appear
- Serial number of your unit

Please feel free to call with any suggestions that you may have regarding the content of your manual.

© 2002 Solectria Corporation

All Rights Reserved

No part of this manual may be reproduced, stored in any retrieval system, or transmitted in any form or by any means (including but not limited to electronic, mechanical, photocopying, and recording) without the prior written permission of Solectria Corporation. This applies to all text, illustrations, tables, and charts.

Table of Contents

<i>Forward</i> _____	2
Caution _____	2
To Report Errors in the Manual _____	2
<i>Table of Contents</i> _____	3
<i>Introduction</i> _____	5
<i>Specifications</i> _____	6
Naming Convention for the Solectria Universal Motor Controller _____	6
<i>How to Use This Manual</i> _____	9
Safety _____	9
Warning Labels _____	9
Safety Symbols _____	10
<i>Installation</i> _____	11
System Requirements _____	11
Before You Install Your UMOC _____	11
Air Cooling Requirements _____	13
Tools _____	14
Vibration Mounts _____	15
Connecting the Motor _____	2
Grounding _____	18
Connecting Your UMOC to Your Motor _____	18
9-Pin Encoder (Speed Sensor) Connection _____	19
25-Pin Ignition Box and Driver Console Connection _____	2
Single-Drive / Ignition Box Systems _____	21
$\Delta\Delta$ For Dual Drive Systems with Console _____	21
$\Delta\Delta$ Regarding 12-Volt Power for Console _____	23
Connecting 12 Volt Power _____	24

Cooling Fan 12-Volt Power _____	24
Voltage Range for 12-volt Power _____	24
♦ Important Note Regarding Keyed 12-Volt Power _____	25
Connecting ‘Regen’ Brake Lights _____	2
Brake Light Direct Connection _____	27
Brake Light Relay Connection _____	27
Brake Light Fuses _____	27
Connecting Your Battery Pack to Your UMOC _____	28
Voltage Ratings _____	28
Safety Precautions _____	29
Making the Battery Pack to UMOC Connection _____	33
9-pin Serial Data Port Connection _____	33
Serial Data Port Protector Cap _____	34
Cable Types _____	34
Shielding Serial Port Cable _____	34
Warnings Regarding Grounding the Serial Port Cable _____	35
<i>Troubleshooting</i> _____	36
<i>Conclusion</i> _____	41
Cleaning _____	42
Checking condition of cables and plugs _____	42
Battery and motor plugs _____	42
<i>Warranty</i> _____	43
<i>Appendices</i> _____	44

Introduction

Congratulations on your purchase of a Solectria Universal Motor Controller (UMOC). By choosing the Solectria UMOC, you join those that have made a commitment to the high efficiency and exceptional design that has set the standard in the electric vehicle industry.

A UMOC is a self-contained, microprocessor controlled, three-phase AC vector control power converter for AC induction or DC brushless traction drive and auxiliary drive motors.

Responding to all input sensors and commands, your UMOC provides all the power outputs necessary to operate the traction motor in an over the road vehicle. In addition to controlling the main traction motor, your UMOC sends the signals that control some of the dashboard displays and exterior signal lighting of the vehicle. All units (except auxiliary drives) can use the AC induction motor as an alternator to generate or recover DC power; switching smoothly under power from motor to alternator and back again whenever needed.

Since Solectria is confident in the craftsmanship of its products and because our components are engineered to work together for maximum efficiency and reliability, we highly recommend that you use our motors and components when designing your vehicle's systems.

Specifications

Naming Convention for the Solectria Universal Motor Controller

The following defines the alphanumeric nomenclature that appears in the model title of your UMOC.

UMOC440 (T), (F) (A) or (S)

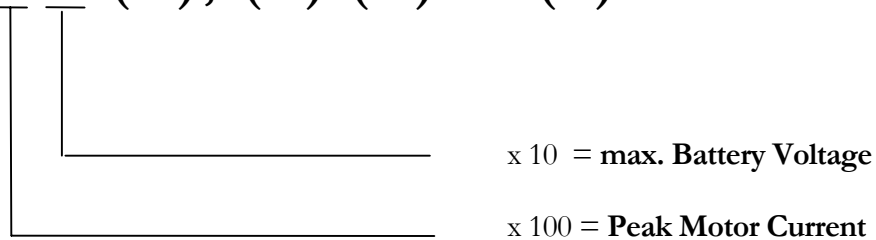

- T= High Efficiency
- F= Heavy Duty Cooling (Standard)
- S= Sensorless UMOC
- A= Auxiliary

For Example: A UMOC640 has a 600A peak motor current and a 400V peak battery voltage

Table 1. List of Models

Model	Special Notes	Battery Min. (Nominal)	Battery Max. (Nominal)	Min Operational Voltages	Max Operational Voltages	Peak RMS Motor Current	Peak Electrical kW	Vehicle type	Weight (lbs)*	Max on Charge Voltage	Max Battery current	Input Wire size AWG	Cooling Fan current (max. amps)@ 12V
UMOC225	Discontinued		144V			140A	20	car	27				
UMOC320T	Discontinued		144V			240A	34	car	27				
UMOC340	Discontinued		312V			210A	65	car	26	400V	180A	4	1.9A
UMOC440, UMOC440F	Discontinued		312V										
AC325						240A	40	car	26				
UMOC425T		120V	192V	120V	250V	280A	45	car	28				
UMOC440T		204V	312V	204V	370V	280A	78	car	28				
UMOC440TF		204V	312V	204V	370V	280A	78	van	35	400V	250A	2	4.4A
UMOC640		156V	312V	120V	370V	420A	100	bus	55	400V	425A	2	4.4A
UMOC645**		156V	336V	120V	370V	420A	110	bus	55				
UMOC340A-> UMOC440T-A	Special		312V			180A	56	inverter	26				
UMOC425T-S	Special		192V			180A	34	inverter	26				
UMOC340S-> UMOC440T-S	Special		312V			180A	56	inverter	26	400V	250A	2	4.4A

*weight does not include cooling fans

** Available first quarter 2000

Table 2. Solectria Available UMOC/Motor Systems

Motor Model	AC10	ACgtx20	AC21	AC25	AC42	AC50	AC55	AC60	AC90*
Peak Torque (Nm)	50	70	90	140	160	145	240	290	630
Max current (A rms)	200A	240A	280A	225A	240A	240A	250A	400A	400A
Continuous Torque (Nm)	10	20	21	25	42	50	55	60	90
Continuous Power (kW)	5kW	12kW	13kW	16kW	21kW	30kW	34kW	36kW	57kW
Peak Efficiency	88%	90%	92%	91%	93%	93%	93%	93%	93%
Motor controller	UMOC425T	AC325	UMOC425T	UMOC425T	UMOC440T	UMOC440TF	UMOC440TF	UMOC640	UMOC645
Peak Electrical Power	17kW	34kW	37kW	30kW	75kW	78kW	78kW	100kW	110kW
at voltage of	144V	144V	144V	144V	312V	312V	312V	312V	336V
Nominal Speed (krpm)	2	4	3	1.2	4	4	2.5	3	2
Max. Speed (krpm)	12	12	12	12	10	10	10	10	6
Weight (lbs)	40	70	86	104	133	198	234	248	440
Diameter (in)	7.6	8.5	9.75	9.75	9.75	13.5	13.5	13.5	15.5
Length (in)	10	11.5	12.13	13	14.5	16-17*	17-18*	18.5	22

*Depending on end bells and options

Components Block Diagram

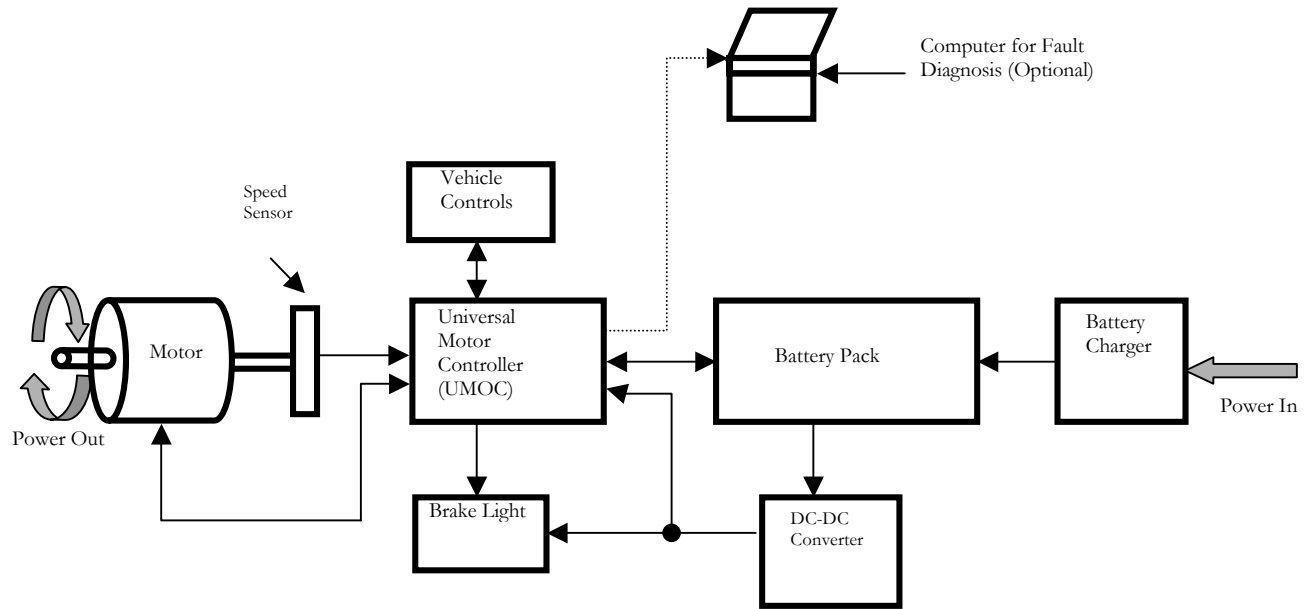

How to Use This Manual

For your safety and the safety of others, please read and understand this entire manual before installing your UMOC. If you have any questions regarding the contents of this manual, please call the Solectria Customer Service Department before proceeding.

Safety

Your UMOC contains voltages sufficient to cause severe personal injury, even after being disconnected from a power source. *Always use caution when operating near sources of high voltage.*

WARNING LABELS

Labels will be located on the right-hand side of the page to indicate areas in a procedure where you should be taking appropriate precautions. Labels include:

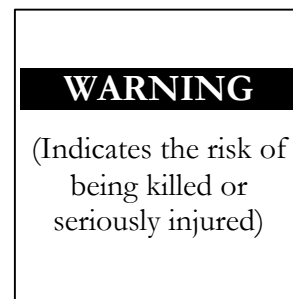
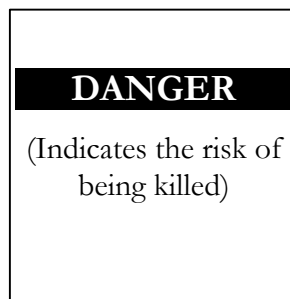
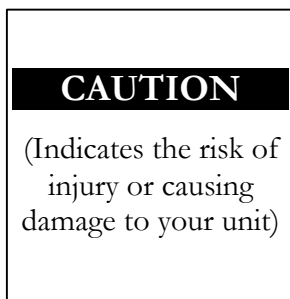

SAFETY SYMBOLS

Always use caution when working on or around any electrical equipment. ***Wear eye protection at all times.*** The following symbols will be located in the right-hand margin of your manual to indicate sections in a procedure where extra caution and/or safety equipment is required.

Hearing Protection Required



Eye Protection Required



Risk of Electrical Shock



Risk of Burns from Battery Acids



Always follow any safety instructions that are given at the beginning of a procedure. If you are uncertain as to the safe and proper handling of your equipment, contact your Solectria Customer Service representative at the phone numbers provided in your warranty before proceeding.

Installation

System Requirements

You must have the following three items in order to ensure that your UMOC will operate properly with the drive system that you have developed.

- A battery pack of sufficient voltage and capacity
- An accessory kit with interface box and accelerator pedal unit connections.
- A motor with an incremental rotary encoder that has been configured to match the programming of the UMOC ♦

♦ **Note:** Motors that use a sensorless UMOC do not require a shaft encoder.

Use the information provided in **Table 1** to help determine that the UMOC you have purchased is compatible with your motor and drive system.

Before You Install Your UMOC

Listed is a set comprehensive installation requirements for your UMOC. When planning a new installation, please consider all of the points on the next page.

- Do not loosen any screws or hardware on the outside of the UMOC case. Each fastener and grommet is carefully tightened with sealant during construction. If fasteners are loosened or removed, the factory seal will be lost. Units received for repairs that have been opened by the customer will be ineligible for warranty coverage.
- Do not drill holes into the case of your UMOC. Use only the mounting holes provided.
- Never remove the mounting brackets from the unit for any reason. If the mounting brackets have been removed, reinstall them with 8-32 stainless-steel screws only. Before installing, holes must be covered with sealant. Use only GE silicone type II sealant. Do not use type I sealant. Type I sealant emits corrosive vapors which are harmful to electronic components.
- If ductwork must be attached to the air intake grills on top of the unit, adhesive strips of Velcro may be applied to the fan housing. The ductwork must be easily removable in order for the UMOC to be serviced.
- Do not attach other vehicle accessories to the top of the vibration mounts. The vibration mounts supplied with the UMOC are matched to the weight of the unit. Besides transmission of unwanted vibrations, attaching objects to the UMOC mounting bolts will make removal and installation difficult.
- When carrying, installing, or removing your UMOC, never lift the unit by the wires.

Air Cooling Requirements

Your UMOC is air cooled for greater electrical efficiency. Ample quantities of outside air must be available to cool your unit.

Unit performance and lifetime will both be reduced if cooling air is not available. Consider this when choosing a location for the unit. Some other key points to keep in mind:

- If ductwork is required, additional blowers must be added to restore the airflow rate to the same level as a unit operating in free air.
- Cooling fans are not designed to draw air through ductwork more than two feet long, with bends, or of a smaller cross-section than the fan air intake opening.

To check for proper airflow, operate the unit under the most demanding conditions (for example, at high ambient temperatures or hill climbing) for 15 minutes. Exhaust air temperature measured at the cooling fins should not exceed 50 degrees Centigrade during this period. The unit **should not be routinely exposed to ambient temperatures above 50 C°** unless equipped with high-power cooling fans designed for warmer climates.

Tools

You will need certain tools in order to install your UMOC. These include:

- A 7/16" socket wrench with extension.
- A small, flat-head screwdriver.
- Electric drill with a 1/4" metal drilling bit.

With Solectria's guidance, you can customize the parameters of your UMOC using a computer with Microsoft HyperTerminal™ communications software. Please call the Solectria Customer Service Department for details.

Use all safety precautions when using metal tools near a source of electricity, or making electrical connections and always wear eye protection.



Vibration Mounts

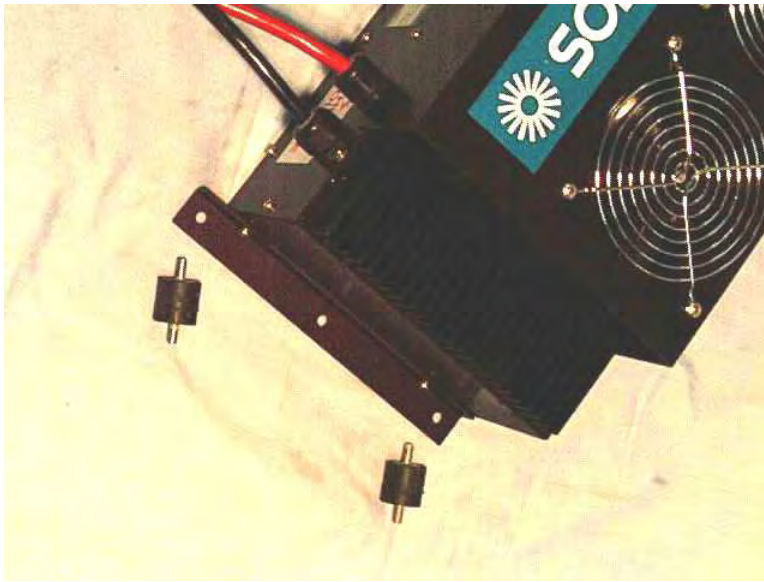

Figure 1: UMOC Vibration Mounts

All electronic systems must be isolated from vehicle vibration. This is done through the use of vibration mounts.

All UMOCs are shipped from the factory with vibration mounts in the accessory kit. If the UMOC is bolted directly to the vehicle frame without the vibration mounts in place, it will be difficult to obtain a unit lifetime of greater than two years.

The factory supplied vibration mounts must be operated in compression, with the weight of the UMOC on them. For improved vibration protection, or when the UMOC is not mounted face-up, heavy-duty Barry mounts must be used. Barry mounts are available through Solectria or from Barry Controls.

Now that you have made sure that your UMOC is located in a safe and dry place, receives sufficient airflow and has been securely mounted, you can now make the connections between your unit and the motor.

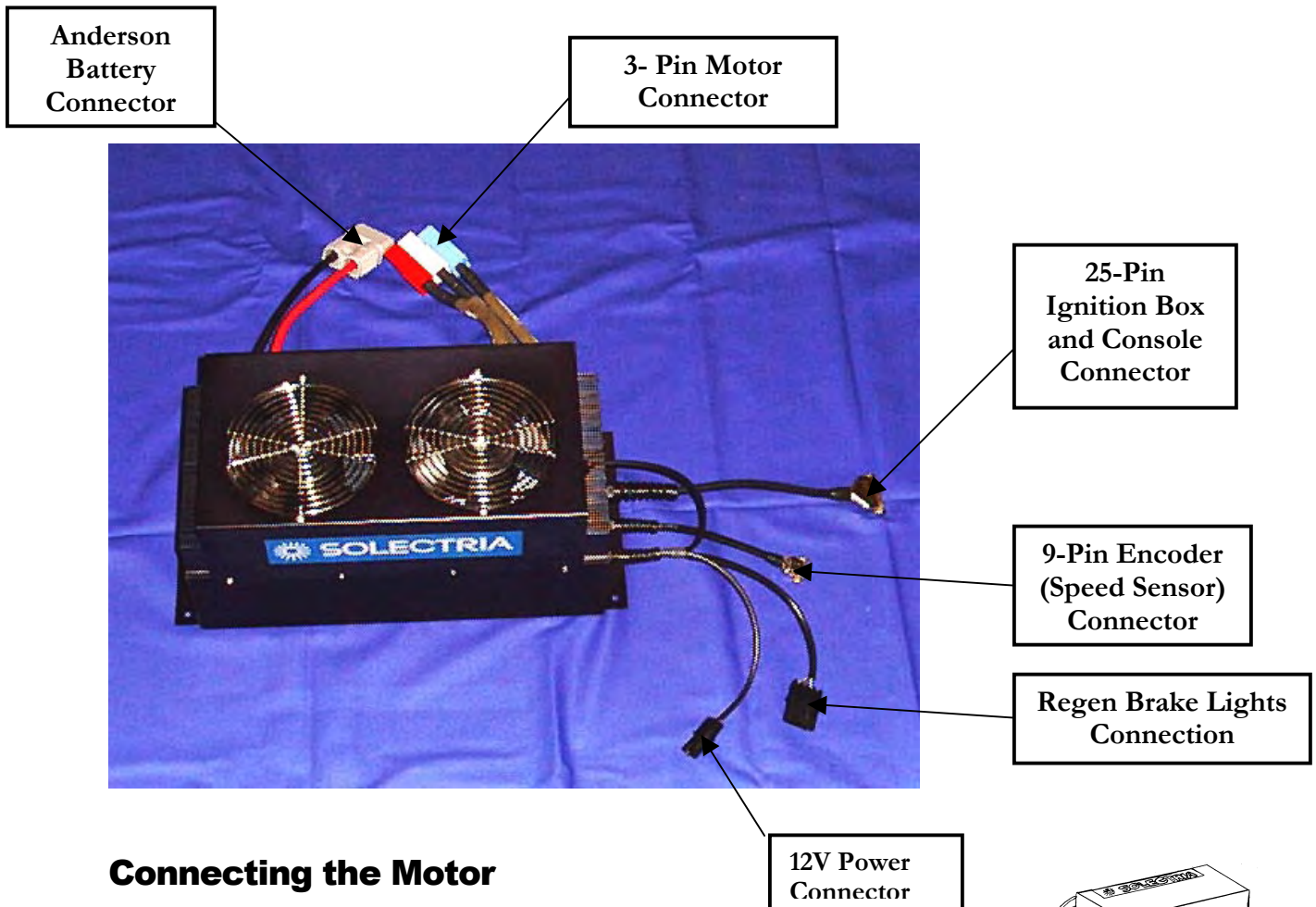

Connecting the Motor

The three color-coded wires (red, white, and blue or other similar colors) connect to the motor. For correct operation, the colors must be matched: red to red, and so forth.

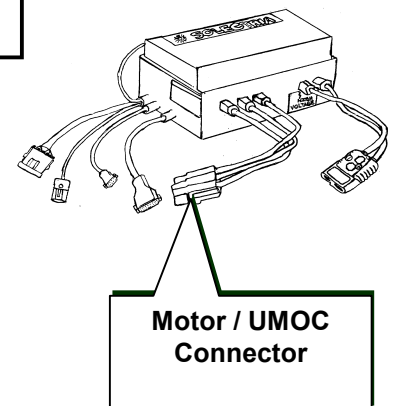

If, during motor wiring or installation, two of the three wires are reversed, the motor will not operate. This is known as Phasing.

UMOC and Motor Phasing

All UMOCs and Solectria motors have been phased properly and motor wire connectors are color-coded before leaving the factory. Use the color-coded plastic connector housings to identify wires. For example, wires without connectors are identified by color bands or by tags reading “Blue,” “Red” or “White”.

Unlike standard industrial 3-phase motors, the direction of rotation is controlled by the microprocessor and cannot be reversed simply by exchanging wires (except for sensorless UMOCs).

Important: to facilitate testing and repair, the colors and ordering of the controller wires must not be changed. Units received for repair with the colors and/or wires out of order will be reset to the original configuration so that they can be tested. Make any required changes to the motor wires, not to the controller wires.



Grounding

To minimize the introduction of noise resulting from poor grounds, ground the motor and the UMOC to the vehicle frame.

The motor housing may be connected to the vehicle frame using a 10 AWG bonding jumper connected to a good grounding point on the motor frame. You can ground your UMOC by placing a ring terminal under one of the four mounting screws.

Vibration mounts on the UMOC insulate the UMOC case from possible grounding. To ground the case, install a bonding wire from one of the UMOC mounting bolts to the vehicle frame. Be sure to use a toothed washer to penetrate the anodized coating on the mounting bracket.

For vehicles with nonmetallic bodies, the motor and controller cases may be bonded to one another with a 10 AWG jumper wire. A signal ground is provided through the encoder (speed sensor) cable.

Connecting Your UMOC to Your Motor

After following all of the guidelines for setting up your motor and your UMOC, you can now connect the two units together. To make the connection, simply push the three-phase, red, white and blue connector pins from the UMOC to the matching red, white and blue connectors of the motor. Once this has been done, you can now make the 9-pin encoder/speed sensor connection between your UMOC and your motor.

CAUTION

The small screws on the mounting brackets must not be removed or loosened.

9-Pin Encoder (Speed Sensor) Connection

The 9-Pin encoder, or 'speed sensor' connection allows your UMOC to monitor the speed, direction and temperature of your motor.

Warnings Regarding the 9-Pin Encoder (Speed Sensor) Cable and Grounding

Since high voltages can develop on the encoder cable, follow these warnings:

- Prevent the possibility of electric shock by switching off the motor controller completely, before connecting or disconnecting the encoder connector.
- Do not handle the encoder (speed sensor) connector while the motor is running.
- While unplugging or fastening the connector, use both hands. Grasp the connector shells by the plastic cable strain relief at its base and not by the metal housing.

Once the 9-pin encoder connection has been made between your motor and your UMOC, you can then move onto connecting the 25-pin cable of your unit to your ignition box or driver's console.

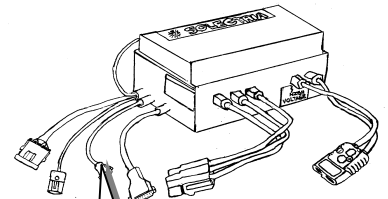

**9-Pin Encoder
(Speed Sensor)
Cable
Connection**

WARNING

**READ ALL
WARNINGS
REGARDING THE
ENCODER (Speed
Sensor)
CONNECTOR**

25-Pin Ignition Box and Driver Console Connection

Now that you have mounted your UMOC, connected the unit to your motor and the 9-pin encoder you can next make the connection between your UMOC and your ignition box (single-drive vehicles) or driver console (used in dual-drive vehicles), using the 25-pin cable link.

Follow all instructions and guidelines regarding the installation of your ignition box or driver console.

For those with dual-drive systems, read all of the information regarding issues specific to your requirements.

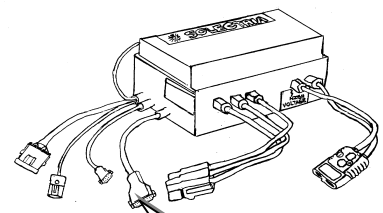

**25-Pin
Ignition Box
and Console
Connection**

Single-Drive / Ignition Box Systems

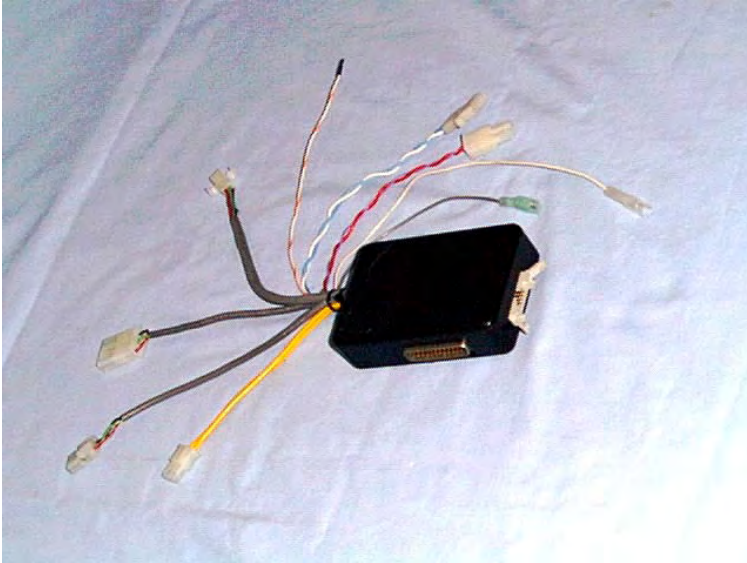

Figure 2: Ignition box

Your ignition or “interface” box should be located in a protected area such as underneath the dash of your vehicle. It should also be kept dry at all times. When all wires are attached and checked, connect the 25-pin cable from the ignition box to the UMOC. See **appendices A and C** for more details.

ΔΔ For Dual Drive Systems with Console

Connect and check all console wiring then choose a mounting location close to the operator’s position, such that the console controls may be reached comfortably by the operator. Avoid locations where any liquids spilled from a nearby drink-holder may enter the console. Also avoid areas near a window, which might be left open to admit rain.

After installation, connect the 25-pin cables, one to each UMOC motor controller.

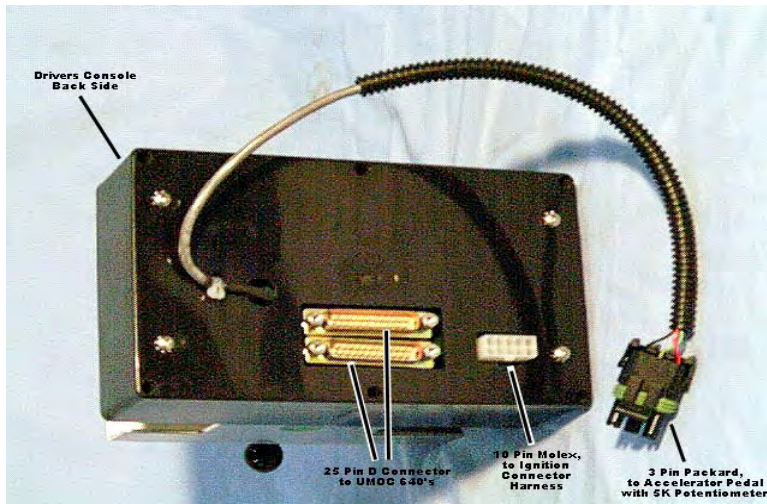
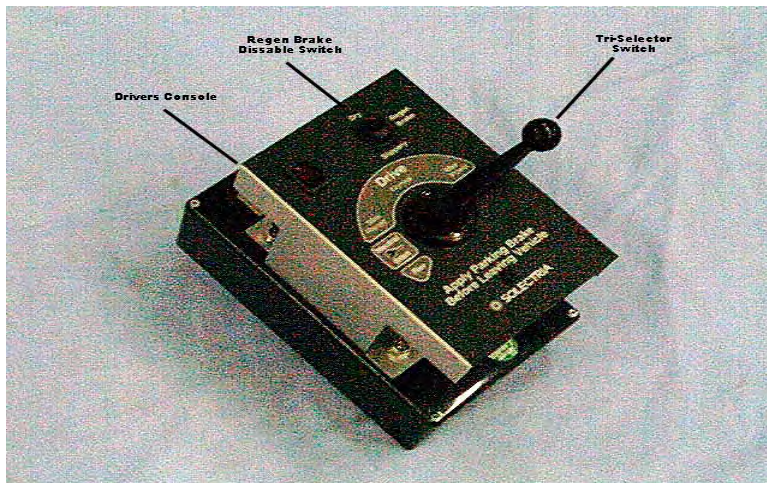

Figure 3: Dual-Drive Driver's Console



If you are operating a dual drive system and wish to test an individual “UMOC / motor system” separately, you must disconnect the 25-pin cable from the “system” not in use. Otherwise, if the disabled system is powered down or malfunctioning, this will affect the working system through interaction between the two units via the 25-pin cables.

Operating the console with one system only will also affect pedal position response. For any pedal adjustments or repairs, be sure both 25-pin cables are connected. Vehicle operation can become unpredictable or stop altogether.

ΔΔRegarding 12-Volt Power for Console

Dual-drive systems will not function if 12-Volt power to the console is lost. If both drive systems operate with a Solectria test box, but neither drive operates with the console, check the 12-volt power input to the console and also the inline fuse(s). Systems without proper UMOC or motor grounding will blow the fuse in the console in the following manner:

If a 12-volt accessory is grounded to either the motor shell or UMOC case, and either the motor or the UMOC is not grounded to the vehicle frame, the only ground path for the 12 volt accessory will be through the ground of the 25-pin cable. To return to vehicle grounding, the ground current then flows through the console's 12-volt return inline fuse. This fuse is not sized to carry large currents. The condition described above is known as a '**ground loop**'. Ground loops must be avoided for reliable vehicle operation.

The console circuit board will be damaged if the inline fuse is removed or replaced with a larger fuse. Instead, it is best to ground the drive system properly to prevent short circuits or poorly grounded accessories.

Once you have made all of the connections necessary for operating your ignition box or driver console, you can now connect your system to the 12-volt power supply.

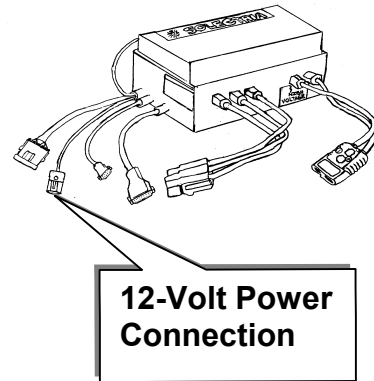

Connecting 12 Volt Power

The signal that tells your UMOC to begin and cease operations is referred to as the **keyed 12 volts**. This 12-Volt signal, supplied when the ignition key of your vehicle is turned to the ‘on’ position, also serves as a 12-volt power source to your UMOC.

Cooling Fan 12-Volt Power

Power for the UMOC cooling fan motors is derived from the keyed 12-volt input. The keyed 12-volt circuit should be capable of supplying the maximum fan current anticipated. (See the fan current table in the “Specifications” section)

Voltage Range for 12-volt Power

The range for the keyed 12-volt power is 11-16 volts. At any voltage below 12.0, cooling fan power is reduced. For an additional charge, Solectria can supply UMOCs for vehicles with 24-volt electrical systems as a special order (except certain models - please contact the factory). This refers to the vehicle’s lighting and auxiliary power circuit and *not* the main battery voltage of an electric vehicle.

CAUTION

Do not allow keyed 12-volt power to rise above 16 volts. Doing so may damage the cooling fans.

◆ IMPORTANT NOTE REGARDING KEYED 12-VOLT
POWER

The negative wire of many 12-volt vehicle accessories is often connected to the metallic vehicle frame. Conversely, many 12-volt accessories have the negative input wire connected to its own metal case. For this reason, never use a section of the main vehicle battery of an electric vehicle to supply 12 volts accessory power. This will unbalance the main battery, causing it to fail. In addition, it creates a hazardous condition.

Be sure not to use the motor shell or UMOC case for a grounding point for other electrical accessories. For example, your motor's cooling blower, motor negative return, must be connected by a separate wire to your vehicle's frame or to a proper ground point. It also must not be connected to the motor case for a ground.

If this should happen, blower motor current or short-circuit current can flow through the encoder cable ground conductor. This can damage the cable ground circuit or introduce noise into the encoder signal. The result will be a malfunction of the drive system. In all cases, 12-volt accessories must be grounded separately to a good vehicle ground, and not grounded to the drive system.

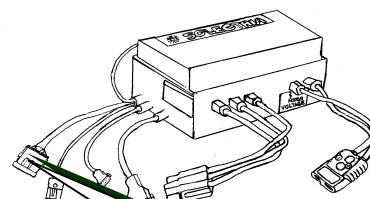

**Regen Brake
Lights Connection**

Connecting ‘Regen’ Brake Lights

It is very important the vehicle brake lights come on whenever the UMOC enters regenerative braking mode. The stop lamp signal is supplied via the UMOC’s 12-volt auxiliary connector. Regenerative or ‘regen’ braking is capable of slowing the vehicle rapidly while returning energy to the battery. Unwanted kinetic energy is converted to electrical energy.

If desired, the UMOC features an additional 12-volt output circuit that may be programmed by special request. UMOC 12-volt auxiliary outputs are isolated “dry contact” type solid-state relays with a 4-amp continuous rating. Outputs are reverse-polarity protected. If connected in reverse, outputs remain “on” continuously as a diagnostic. Outputs must be fused with external 4-amp fuses.

Your UMOC accessory kit contains a forward/reverse selector switch that also features a dry contact output to supply power to the vehicle reverse lights. Current capacity is higher than the UMOC’s programmable light output. The forward/reverse selector switch contacts are rated at 10 amps.

To make contact between the 4-pin Packard connector from your brake amp circuit and the other from your UMOC, simply push the two halves of the connector together until you hear the ‘click’ of the two halves locking into place.

Brake Light Direct Connection

For small lightweight vehicles using LED brake lights without large ballast resistors, or vehicles with small incandescent lamps, the brake light circuit may be connected directly to the brake light output of your UMOC. An external four-amp fuse must be included in the circuit. A smaller size fuse may be used. Do not use a fuse size larger than 4 amp, or connect loads larger than 4-amp.

Brake Light Relay Connection

For larger vehicles using several incandescent brake lights with a total current drain exceeding four amps, the brake lights are connected to external brake light relay, supplied by Solectria. The brake light relay then connects to the regen brake output of your UMOC. In all cases, the brake lights are connected such that the pressing the brake pedal activates the brake lights as well. See **appendix B** for details.

Brake Light Fuses

Auxiliary circuit fuses are not located within the sealed UMOC case. This makes fuse replacement easier. External fuses can be installed in a convenient location by the customer. To prevent damage to internal solid-state relays in the event of a short-circuit, fuse sizes for UMOC 12-volt output circuits must not exceed four-amps. For custom installations, Solectria can supply properly rated fuses, fuse holders, and fuse holder mounting boxes at competitive prices.

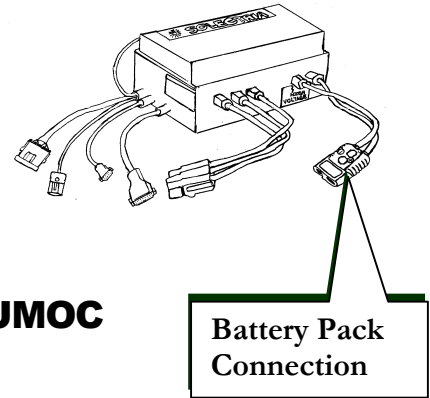

Connecting Your Battery Pack to Your UMOC

Once the motor connections have been made, you can now proceed to connect your battery pack to your UMOC unit. Follow all of the instructions regarding safety. Read all section text before attempting any of the procedures described.

Voltage Ratings

Units leaving the factory are programmed for a designated battery voltage. All units have both minimum and maximum voltage settings.

To assure good operation during all states of charge and for good battery protection, battery voltage settings must match the actual battery pack in use. When the battery becomes depleted during operation, motor torque is limited by the UMOC's operating software to prevent battery damage. During charging, battery voltage may increase beyond the operating limits. This is permissible, as long as charging voltage does not exceed ratings.



Safety Precautions

Read all of the following safety precautions before beginning work on your battery pack.

- Use insulated tools and always give electricity the respect it deserves. High voltage battery packs *can kill*.
- Use an approved face shield when making connections.
- When replacing a connector housing, *remove and re-insert only one pin at a time*. That way, the pins will not come in contact with each other.
- Never connect any terminals of a battery to the vehicle frame, as is commonly done with 12-volt vehicle power.
- All exposed metal surfaces carrying battery current such as fuses, terminals, shunts, switches and the like should be placed beneath a protective cover or inside an insulated box.
- All battery wiring components mentioned directly above must be properly sized and rated to safely carry the maximum current that will flow through them.
- Bare metal surfaces carrying opposite polarity DC battery current (positive and negative) inside fuse and connection boxes must be separated as much as possible to avoid mutual contact by metal tools or other parts. We recommend a minimum of six inches.
- Never use a bare metal plate for a battery box cover. The vehicle could roll in an accident and the battery terminals fall against the cover. An insulating sheet of 94V-0, G-10 fiberglass of 0.060 thickness is ideal for this purpose.

- Battery connectors must be located where they will not come in contact with water or fine spray mists of road salt, and where the connectors are free to drain and dry quickly if they do get wet. Important: Battery connectors must not sit on a horizontal surface where they could remain wet.
- Battery cables must be of an appropriate voltage rating, should not run near sharp edges, and should be attached every 6 to 8 inches to an insulated surface.
- Battery wires must be *individually* covered with protective wire loom and must remain separated from each other by 4 to 6 inches wherever possible to prevent conditions that might sustain an electric arc. Arcs can be initiated by water and salt entering the battery plugs, or by physical damage from a road accident.
- Check voltmeter for proper range and lead connection before touching test probes to battery pack or connectors. (If the voltmeter is set to a current range, or the test leads are plugged into the current inputs, this will blow a fuse or damage the voltmeter. This may cause personal injury.)
- Work with one hand behind the back when making connections. This greatly reduces the chance of heart failure caused by an electric current flowing through the chest area.
- Workers should be trained in CPR and correct response procedures regarding electrical shock.
- Never open your UMOC. Residual stored energy may exist for several hours after disconnection from the battery.

- Do not touch the metal terminals of the UMOC battery plug.
- Do not allow children to handle the DC battery connector plugs of electric vehicles. As long as battery plugs remain connected, there is little or no danger. Unplugging the connectors exposes the holes containing the live contacts down inside the plugs.
- Keep fingers away from internal contacts when working on battery plugs.
- When working on high-voltage systems, never work alone.

◆*Note: New product warranty coverage does not apply to units that have been opened.*

WARNING

The bolts of all cables carrying battery current must be torque tightened to the battery manufacturers specifications. Failure to do so can result in the catastrophic failure of your system. Also, be sure to use lock-washers at all such connections.

Making the Battery Pack to UMOC Connection

To make contact between the battery pack and your UMOC, simply push the corresponding ends of the connector together until you hear the ‘click’ of the two halves locking into place.

9-pin Serial Data Port Connection

The serial data port is used for communication between the UMOC and a personal computer that uses a Windows™ operating system. A **9-pin, shielded straight-through cable** can be connected to your unit and run to the passenger compartment of the vehicle. The cable can then be left connected for the monitoring or logging of data. It is also possible to fine-tune the settings of your UMOC while driving, using a laptop computer connected to the serial data port.

This information is covered in-depth in the Solectria UMOC service manual. Call the Solectria Customer Service Department for details.

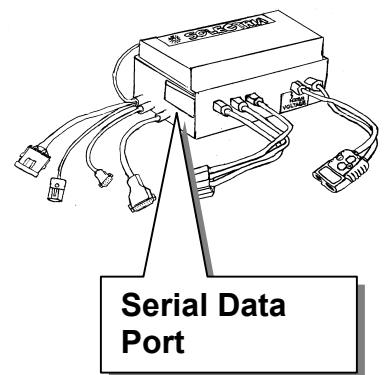

Serial Data Port Protector Cap

The serial data port connector is protected from dirt and moisture by a red plastic cap. Always replace the cap when the serial port is not in use to prevent electrostatic discharge (ESD), dirt, or dust from entering the serial port. Additional caps are available from Solectria, (part # DB 9-F dust cap), or from Radio Shack.

Cable Types

When connecting to the serial port, you must use a straight-through cable. **Do not use a null-modem cable.** *Null-modem* cables have internal connections that may be harmful to the unit and no data will be received. If in doubt, test the cable with an ohmmeter before using.

Each pin, on one end of the cable, should connect (have continuity) to the same-numbered pin on the opposite end of the cable.

Only certain early model UMOCs that have a white-colored data connector require a null-modem adapter or null-modem cable.

Shielding Serial Port Cable

While not absolutely necessary, the serial port cable should be shielded with an internal metal foil or braid. All good-quality computer serial cables are shielded. **Do not use homemade cables.** Operating the unit with an unshielded cable will introduce noise into the serial port connection, may cause data errors, poor performance and unpredictable response.

CAUTION

Do not use a null-modem cable for your serial data port connection.

Warnings Regarding Grounding the Serial Port Cable

- When installing and testing a new system for the first time, it is best to use a portable computer running off battery power. **Do not** ground the cable at the UMOC.
- The metal jackscrews on your UMOC's case are grounded to the case. Use a cable with a plastic plug, or remove the jackscrews from the cable if operating a computer from AC mains power.
- Your UMOC's serial port is optically isolated from the unit. Grounding the serial cable to the UMOC jackscrews will defeat this isolation.
- Any fault current (from a malfunctioning battery charger or other device) flowing to the vehicle frame will then flow through the serial cable and through the computer, to ground, if the ground connection exists in the cable. **This may damage the computer's ground system.**

Troubleshooting

The following troubleshooting guide can be used to help you diagnose and resolve some of the problems that can arise during operation of your UMOC. The guide can be used for all units **EXCEPT SENSORLESS**.

If, after trying all of the solutions given in the guide, your unit is still not operating properly, call the Solectria Customer Service Department for more information.

Symptom or Problem	Possible Cause	Possible Solutions
UMOC IS NOT FUNCTIONING	1) No main battery power to UMOC 2) UMOC internal capacitors have not had sufficient time to reform 3) One or more of the UMOC connectors are unplugged. 4) No 12V signal to UMOC 5) No 12V signal or ground to ignition box. 6) Blown 12V fuse at ignition box or console.	1) Check battery pack fuse *Note: There should be no external contactors between the battery and your UMOC. If your design includes contactors, remove them; they may be the cause of your problem. 2) After connecting your UMOC to your batteries, wait 15 minutes for every 1-month that the unit has not been connected to the battery pack. 3) Double-check all UMOC connections. 4) Check your vehicle's key is turned to the on position 5) Check your vehicle's wiring harness for a proper 12V circuit. 6) Check fuse. Do not ground accessories to motor or UMOC (Fans, lights, etc)

Symptom or Problem	Possible Cause	Possible Solutions
UMOC IS NOT FUNCTIONING (Cont'd)	<p>7) No pedal signal to ignition box.</p> <p>8) Battery voltage is too high or too low</p> <p>9) Motor or UMOC is overheated.</p> <p>10) Charger is still plugged in. Charger disable interlock is activated.</p> <p>11) Neutral Safety Interlock is activated</p>	<p>7) Check pedal potentiometer wiring to ignition box or console.</p> <p>8) Measure your battery voltage and compare to the spec. sheet of your UMOC.</p> <p>9) Generally, your UMOC will begin limiting power when the unit reaches 60°C, and will shut down completely at 75°C. Your unit will also limit power when your motor's temp. reaches 100°C and will shut down completely when the motor temp. is 105°C.</p> <p>10) Unplug your charger.</p> <p>11) Switch your ignition key to the "on" position with the tri-power selector switch in the "off" or "neutral" position, or turn selector to the "off" position before moving it to the "Forward" or reverse positions.</p>
Vehicle is shuddering, bucking or vibrating	<p>1) Low tire pressure or excessive flex in the sidewalls of the tire.</p> <p>2) One or more defective battery modules.</p>	<p>1) Keep tires inflated to the maximum recommended pressure. This will also help to improve vehicle range.</p> <p>2) Perform a battery discharge test. Check integrity of battery interconnects. Look for signs of thermal damage.</p>

Symptom or Problem	Possible Cause	Possible Solutions
<p style="text-align: center;">Vehicle is shuddering, bucking or vibrating (Cont'd.)</p>	<p>3) Incorrect voltage or motor parameter setting</p>	<p>3) Check unit spec. sheet against requested parameter settings and actual system voltage or motor data.</p>
	<p>4) Regen power is going into an already full battery pack.</p>	<p>4) Some vibration under this condition is acceptable.</p>
	<p>5) Motor speed sensor is out of adjustment or defective. (This is not likely with later model T-60 magnetic sensors)</p>	<p>5) Inspect and adjust motor speed sensor clearance. Check for water or damage at motor speed sensor compartment.</p>
	<p>6) Defective motor speed sensor cable.</p>	<p>6) To test, wiggle the cable and cable ends. Using an ohmmeter, check for continuity from UMOC case to motor case through the 9-pin cable's metal shell.</p>
	<p>7) Too much axial load on motor.</p>	<p>7) Check for poor drive system design, which forces excessive transmission load onto motor shaft.</p>
<p>8) Drive shaft out of phase</p>	<p>8) Check for correct drive shaft phasing.</p>	

Symptom or Problem	Possible Cause	Possible Solutions
Unit runs for a few seconds, then stops.	1) Loose or defective motor wire connectors. 2) Loose or defective battery wire connectors. 3) Defective Battery 4) Unit damaged internally	1) Examine motor phase wires inside of the Anderson connectors and the motor junction block. 2) Examine UMOC wires inside Anderson connector and all battery inter-connect wires. 3) Check battery voltage under load. 4) Return unit to Solectria.
Unit runs for 5-10 minutes, then either loses power or stops operating.	1) UMOC cooling fans are defective or not plugged in. 2) Excessive ambient temp. (Above 30°C) in UMOC compartment. 3) Motor overheating 4) Motor cooling fans inoperative. 5) One or more defective batteries.	1) Check the UMOC's 2-pin, 12V connection to fan assembly. 2) Improve venting in UMOC compartment. 3) Improve venting in motor compartment. 4) If equipped, check motor cooling fan circuit. 5) Perform a battery discharge test.
Motor turns slowly	1) Motor speed sensor cable is unplugged. 2) Broken or damaged motor speed sensor cable.	1) Check the motor speed sensor cable connection at the UMOC. 2) Wiggle the cable at connector and examine closely for water damage or defects.

Symptom or Problem	Possible Cause	Possible Solutions
Motor turns slowly (Cont'd)	3) Motor speed sensor is defective. 4) Internal damage to speed sensor port. 5) Vehicle's brakes are dragging or emergency brake is engaged.	3) Unplug motor speed sensor and see if symptoms continue exactly as when sensor was plugged in. 4) Send unit back to Solectria 5) Check to see if your vehicle is able to roll freely.
Brake lights stay on.	1) Wires C and D are interchanged on the vehicle's side of the 4-pin Packard connection.	1) Check wiring at the 4-pin Packard connection.
UMOC cooling fans are running constantly.	1) UMOC ambient temperature is above 30°C. 2) The 12V key's "on" signal is interchanged with the fan's input.	1) Provide better cooling in UMOC compartment. 2) Swap the 2-pin Packard connections.

Conclusion

This concludes the text describing the specifications, installation and troubleshooting of your Solectria Universal Motor Controller (UMOC).

Using this manual should have helped you accomplish the following tasks:

- Decide upon an appropriate location for your unit, keeping in mind environmental conditions.
- Mount your unit.
- Make the connections required for operating your unit using the steps provided.
- Troubleshoot your unit should a problem arise during operation.

Your UMOC was constructed with the highest standards for quality and design possible. We hope that this manual will enable you to more fully understand the workings of your unit and to use it safely.

If you have had any questions regarding the contents of this manual or would like to know more about the features of your UMOC, please feel free to contact the Solectria Customer Service Department at the phone numbers provided in your warranty.

Maintenance

Cleaning

Provided the needed access is available, simply remove any insects and debris from the cooling fins. Also remove any visible road salt residue by wiping with a damp cloth. If allowed to remain on the unit, corrosion and connector damage may result from the presence of salt residues.

Checking condition of cables and plugs

Battery and motor plugs

Check motor and battery plugs for signs of overheating and melting. Plugs should be removable, but not too easily. Always be sure plugs are inserted *completely*.

CAUTION

Do not use a pressure-sprayer to clean drive system components, including the UMOC. Spray will be forced inside the UMOC case, encoder housing and connectors. This will cause a malfunction and may result in a shock hazard.

DANGER

For systems with battery voltages of 250 and higher, battery plugs must be in a dry location, and must not be wrapped. If the connector is in a poorly chosen location and becomes encrusted with road salt residues, upon exposure to water the connector may burst into flame.

Warranty

In an effort to keep our customers completely satisfied with the quality and performance of items purchased from Solectria, the following warranty policy applies.

Solectria Corporation shall pay for the repair or replacement (at our option) of any component found to be defective due to flaws in materials and/or workmanship within the first 12 months following the date of sale with no (US\$0.00) deductible, with the exceptions noted below. The customer shall pay for the shipping cost (UPS ground) to return the unit(s) to Solectria. For warranty repairs and replacements, Solectria will pay the shipping costs (UPS ground) of returning the unit to the customer. Solectria will not pay for the cost of rush delivery.

For the purpose of this warranty, components include but are not limited to motors, motor controllers, DC-DC converters, battery chargers, amp-hour counters, etc.

This warranty **does not cover:**

1. Products that have been opened, tampered with, or modified in any way.
2. Items defined as routine maintenance.
3. Damage caused by misuse, accident, alteration, lack of maintenance, inadequate packaging or use of incorrect lubricants.
4. Damage or corrosion caused by exposure to after-market products, the environment, or chemical treatments, and;
5. Wear items including but not limited to extension cords, plugs, connectors, cables, and enclosures.
6. Damage caused by improper parameter settings

In the event that it becomes necessary to return a product to us for service, call ahead for a Return of Merchandise Authorization Number. Any item being returned should be wrapped securely in the original or similar packaging to prevent damage in transit. Use the following guidelines for packing your unit for return shipment.

Keep your shipping carton!

Your carton is specially designed to prevent shipping damage to the metal case and cable connectors of your unit. If the carton is lost, Solectria will supply a replacement carton for a fee.

If the unit must be shipped immediately, you must triple-wrap it with large cell bubble-pack and place it securely in a double-walled, corrugated carton for shipment back to Solectria. Any repair costs for the unit that are associated with case damage due to improper shipment will be borne by the carrier or the customer and will affect your warranty.

Returned items should be sent to:

Solectria Corporation
ATTN: RMA # _____
9 Forbes Road
Woburn, MA 01801

All items returned for repair must include the RMA number on the outside of the box. If a shipment is received without an RMA number the shipment will be refused for return to the sender.

Customer will be charged an evaluation fee for Non-Warranty items returned to Solectria. Warranty items returned to Solectria that are found operable will also incur an evaluation fee. Call Solectria's Customer Service Department for details.

Appendices

APPENDIX B

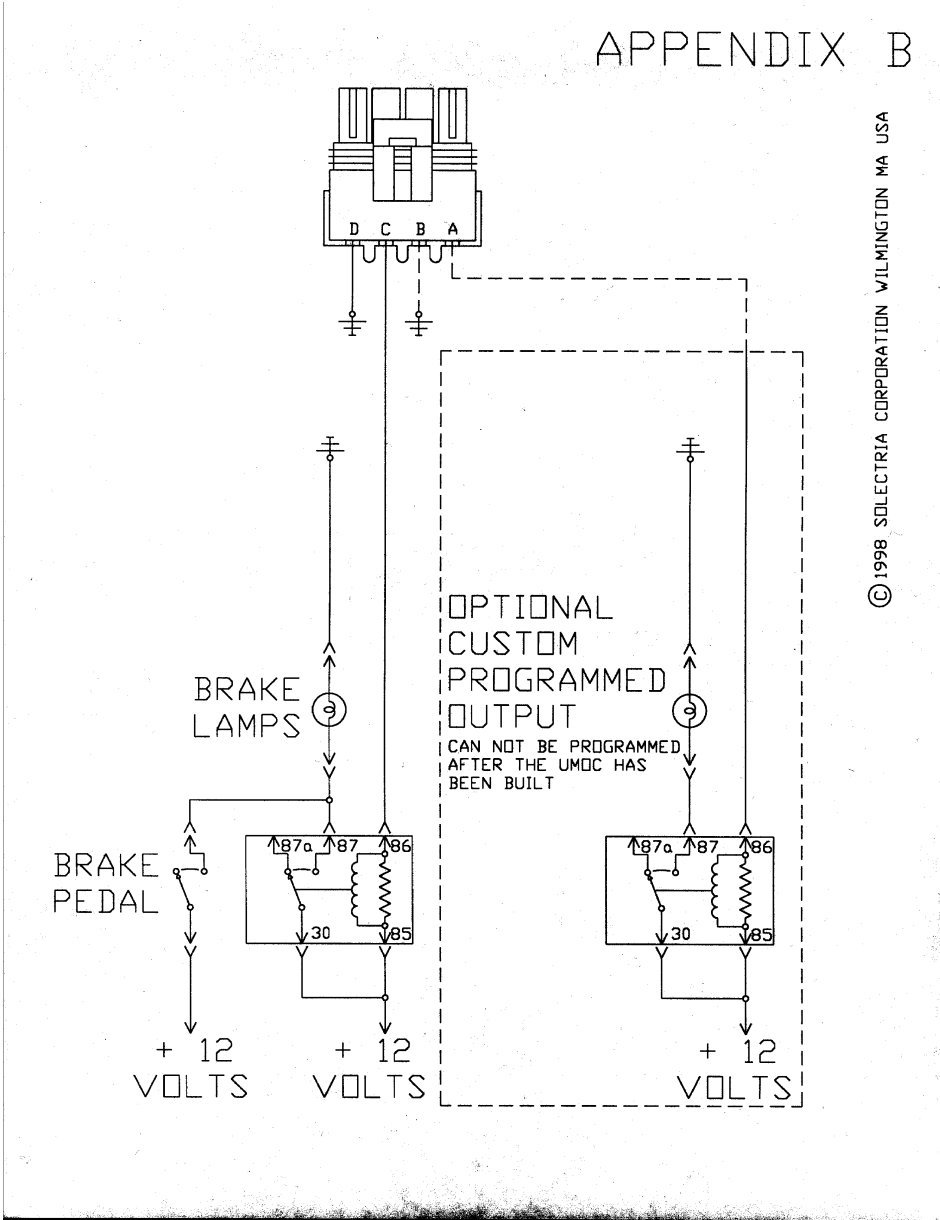

APPENDIX C

CHARGER INTERLOCK
CONTROLLER DISABLE

1234

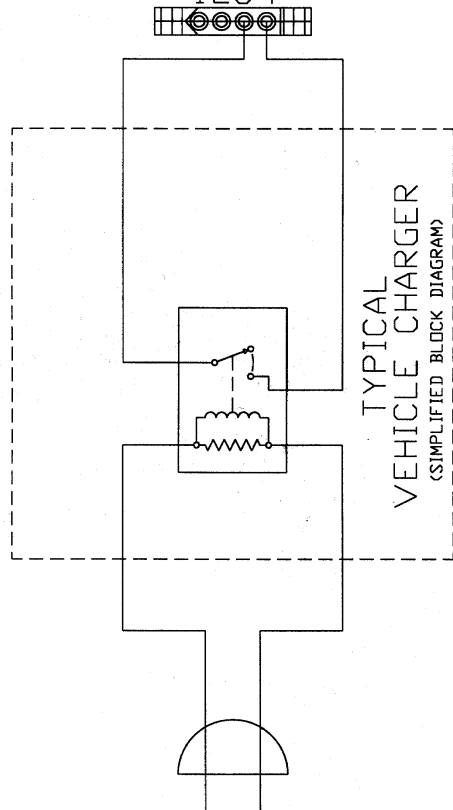

© 1998 SOLECTRIA CORPORATION WILMINGTON MA USA

FROM A.C. MAINS TO VEHICLE CHARGER